

8x8 fan deck with 315W motor

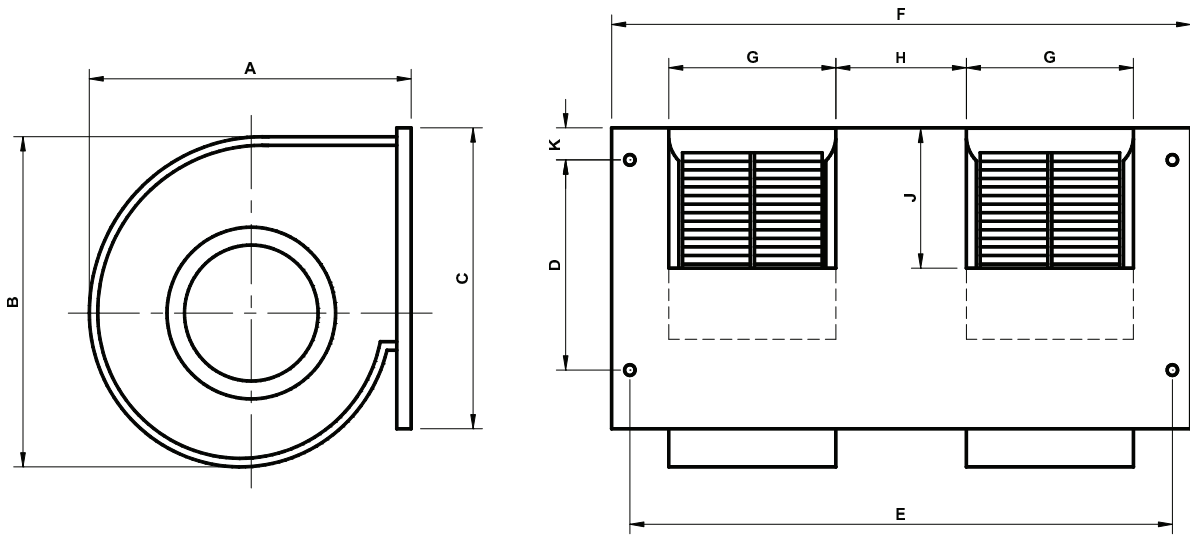

Part Number	A	B	C	D	E	F	G	H	J	K	Nutsert
FD 8x8-315-01	280	320	308	255	760	810	250	205	163	25	M6

Motor					
Rated Output 315W	Supply 240V/50Hz	Rated RPM 1350	Rated Current 2.5 amps	Capacitor 4uF/440V	Insulation Class B 130
Enclosure IP20	Thermal Protection Auto Reset Overload		Duty AOM		

Wheels
Glass Filled Nylon or Glass Filled Polypropylene with plated mild steel hub

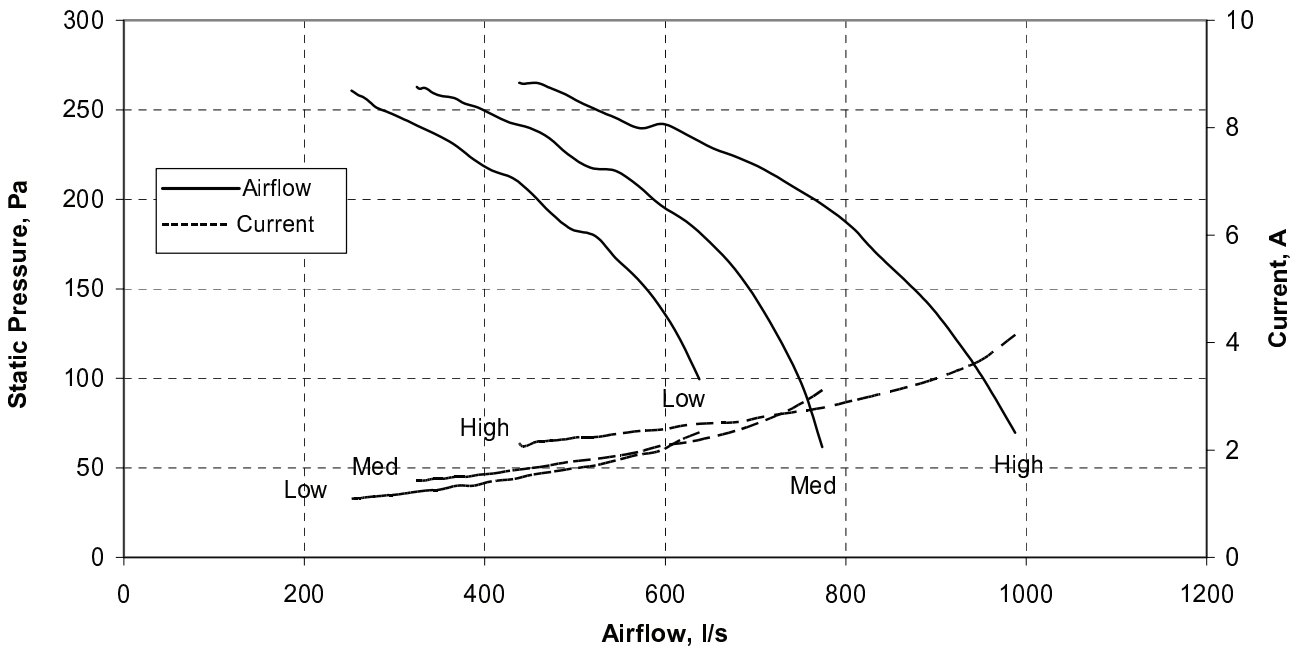

Dimensions

Product Data

Performance